



www.daray.com

DARAY[®]
Medical

0800 804 8384

VISUALLY BETTER

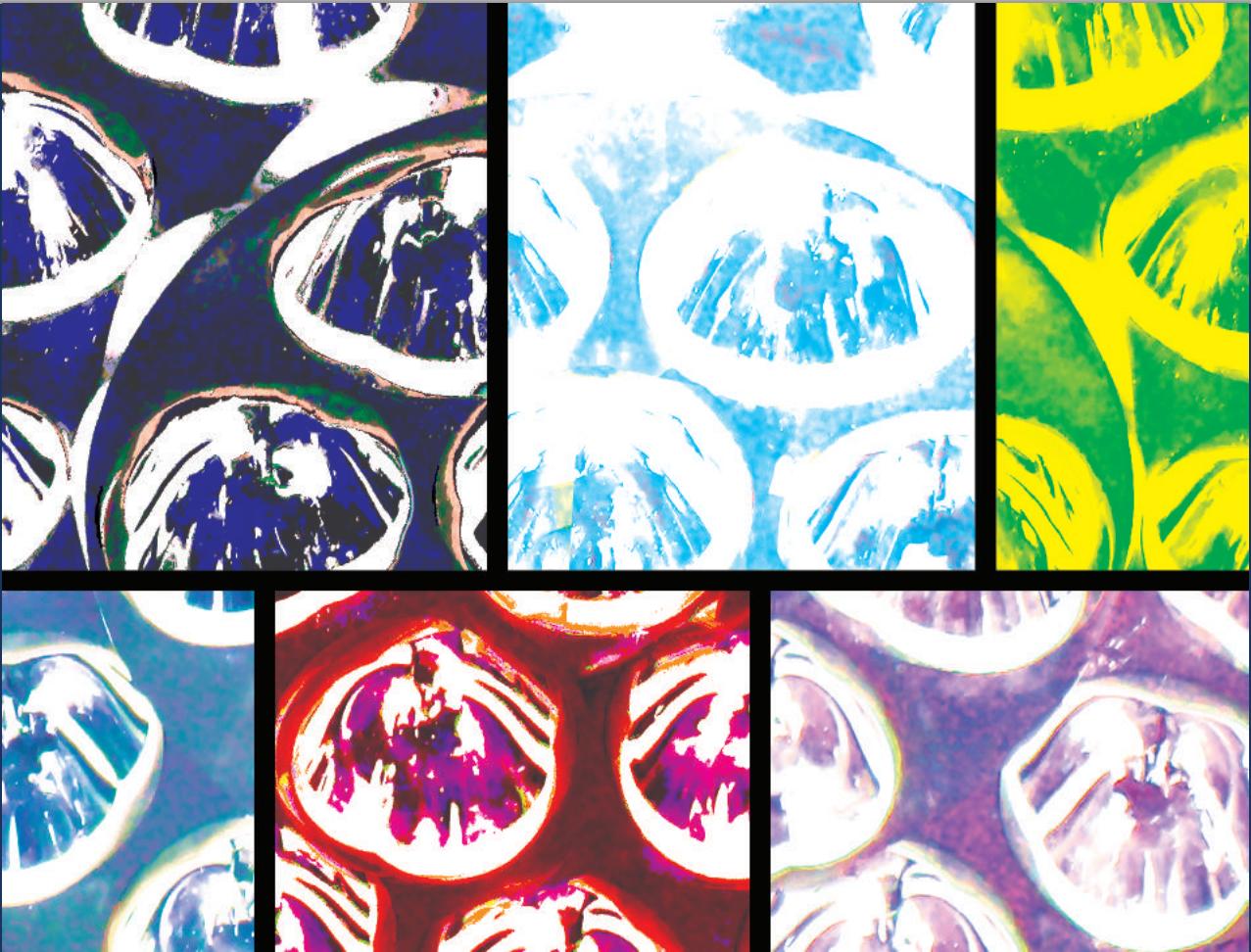

DARAY[®]
Medical

X SERIES

LED Examination Lighting Product Guide

DARAY[®]

Medical

X

SERIES

LIGHTING YOUR WAY

Examination lighting for a range of clinical applications

DARAY is a British privately-owned company based in Derbyshire, United Kingdom and has been designing and manufacturing specialist lighting since 1968.

DARAY continues to develop their product range; producing a comprehensive medical lighting range, including operating theatre, examination and patient lighting to support the needs of medical professionals.

In more recent years, we have expanded our specialist lighting range by including x-ray film viewers and surgical headlights in order for us to provide a total patient management solution.

DARAY products are designed for Medical, Dental and Veterinary markets and we are a preferred supplier to the NHS. Our comprehensive range of lights are often the first choice in 'new build' hospitals and medical centres throughout the UK.

DARAY have always aimed to exceed customer expectations and we continue to invest in new product development.

Our range is constantly expanding in an effort to assist in the reduction of carbon emissions, whilst providing high quality lighting products. We continue to work hard developing new products for the future.

Quality and customer service.

DARAY recognise that customers are professionals who demand the same quality of service as their patients expect of the, and are proud to be accredited to the current versions of ISO 9001 and ISO 13485.

DARAY's designs conform to BS EN 60601-2-41.



All products carry CE marking. **CE**

0800 804 8384

Lines open Monday to Friday 8:30am-5pm or email sales@daray.co.uk.
Please call our dedicated sales team for pricing.

CONTENTS

	5..... X1	
	6..... X2	
	10..... X3	
	13..... X4	
	16..... X4	
	20..... X7	
	24..... Quick reference guide	

ALSO AVAILABLE FROM DARAY...



Surgical and Operating Theatre Lighting



Specialist Lighting Products

CONTACT OUR SALES TEAM to discuss your requirements or to request a brochure.

LED Technology

How does it benefit you?

DARAY's LED lighting is the perfect choice for value and performance. LEDs provide a technological solution to the inherent problems of the incandescent light bulb. Our LED lights are designed to replace halogen lighting completely, saving you time and money, whilst reducing your carbon footprint.

We have continued to develop LED technology to provide high definition lighting with high brightness, low environmental impact, low power usage, no infrared, no toxic materials and a long operating life.

1. Long lifespan

A core benefit of LED lighting is the lifespan of the LED module. With most of our lighting products, you can expect a life of approximately 50,000 hours. Let's say the light is in use for 5 hours a day, that's roughly 20-25 years of use from the LED light engine without ever needing to change the bulb – reducing waste by 95% over the lifetime of the product.

2. Energy and cost efficiency

LED lights have an approximate energy efficiency of around 85-90%. This means that, of the total electrical energy used, 85% is used to actually produce light, with the remaining 15% being lost and converted into heat (still only producing a 2°C increase).

By comparison, a halogen or an Incandescent light bulb has an efficiency of only 20% - meaning that 80% of the total electrical energy used is lost to heat! An electricity bill of £100 for lighting equates to £80 of it spent on lost energy. Switching totally to LED, the same bill would be about £15 – a saving of £85. This would be huge savings for a hospital.

Consider the extra funding available to a hospital that has switched all of its lights to LED, and reduced its annual lighting bill by approximately 75-80%. Imagine what this money could be better spent on? Additional staff? Extra equipment? More efficient maintenance? Better quality of care for patients? So, why waste money on producing unnecessary and harmful heat?

3. Low environmental impact

LED lights, by nature, are free of all toxic chemicals. Most conventional lighting types commonly found in healthcare establishments, such as fluorescent and halogen bulbs contain many materials that are harmful to the environment, such as halogen, mercury, cadmium, lead and CFCs.

LED lights are 100% recyclable – further helping you to reduce your carbon footprint. The long operational lifespan also means that just one light converted to LED can save material and production of 25 equivalent incandescent, fluorescent or halogen bulbs.

4. Zero heat in the beam and zero UV emissions

Illumination by LED light produces absolutely no UV (ultraviolet) emissions, and very little infrared light. As a result, the very low radiated heat emission of LED lighting makes them highly suitable in a clinical environment, for illumination of both humans and animals, due to our UV-sensitive skin and delicate eyes.

5. Increased visual acuity

It remains a scientific fact that using LED lighting enhances your visual acuity; reducing headaches, fatigue and eye-strain. This is because an LED source delivers more 'usable' light to your retina, in part due to the high brightness and more natural colour temperature - essentially decreasing the amount of work that your eyes and brain have to do to distinguish one object from another. This helps contribute to, increased mental focus, faster responses, and reduced anxiety.

The superior colour rendering helps further by allowing you to better differentiate between tissue colours and tones (see *Colour Temperature Explained* p.22).

6. Dispersal of Light

Our lights feature a strong beam of light with an even intensity across the entire area for clearer viewing and reduced eye strain. Halogen type lights, for example, use mirrored reflectors to help disperse the beam. These reflectors are covered with a dichroic filter, which can become stained over time with the high heat levels it is exposed to with constant use, reducing the actual light output long before the bulb has reached the end of its life.

LED lighting, on the other hand, has no reflector and is designed to focus its light beam, achieving a much higher efficiency to the viewed area than other types of light. DARAY spends a lot of time on research and development of our lighting systems to ensure that they are able deliver the required amount of light to the subject far more efficiently.

7. Flexibility of

Design

The lighting products in our range that are intended for medical use, are designed with a circular light patch to match the intended clinical application on the human body. Our dental lights produce a rectangular light patch, as required for oral surgery limiting it to the mouth area only and avoiding the eye area, ensuring ultimate patient comfort.

Some of our lights have a different fixed colour temperature than the others, and some come with adjustable levels (see *Colour Temperature Explained* pg.22, or *The Discovery Zone* at www.daray.com). All models (except for the X1) have variable intensity functions, for dimming the light.

8. Safety

With a surface temperature rise of only 2°C, the risk of a patient or user burning themselves on a hot light bulb are entirely eradicated. All of our LED lights utilise a low voltage power supply, and the light fittings adhere to the anti-ligature requirements of the NHS.



X1

The **DARAY**® X1 LED examination light is the perfect choice for value and performance.

- Infection controlling design
- Low total cost of ownership
- 12,000 lux intensity \pm 500 @ 0.5m
- 3,500 lux intensity \pm 500 @ 1.0m
- 4,000K colour temperature
- Flexible arm and solid positioning
- Wall, desk, mobile and rail mount options available

X1 options and specs

X1 models available

X100LW	X1 wall mounted LED examination light
X100LR	X1 rail mounted LED examination light
X100LD	X1 desk clamp LED examination light
X100LDS	X1 weighted desk stand LED examination light
X100LFDM	X1 fixed desk mount LED examination light
X100LM	X1 mobile LED examination light
XRAIL	Medical rail 1m length with fixings

All X1 models are supplied with a plug-top power supply.

X1 specifications

Light source	LED (7W)
Light intensity @ 0.5m	12,000 lux \pm 500
Light intensity @ 1.0m	3,500 lux \pm 500
Colour temperature	4,000K
Supply voltage	12V 50Hz plug-top PSU
Arm length	1000mm



X₂

The **DARAY**® X2 LED examination lights are specifically designed for use during medical consultation and diagnosis.

Utilising LED technology, this general examination light has been developed to provide an intense beam with excellent colour rendering properties.

The X2 model has a low 'total cost of ownership', costing up to 75% less to run than equivalent halogen lights. This light has around 50,000 hours of life from the LED light engine equating to around 25 years of clinical use.

The X2 model requires minimal maintenance and has a smooth, fully enclosed BioProtect® head to assist with the management of infection control. This is an ideal light for GP surgeries and clinics where flexibility and performance are crucial.

Choose between a flexible gooseneck, a spring balanced arm and many other different mounting options depending on your application, including: wall, mobile, ceiling and bed-panel mount.



BioProtect® is an antimicrobial solution coating applied to DARAY's products for infection control.

Infection is the highest risk in patient environments. BioProtect® provides excellent protection against bacteria such as MRSA, Salmonella, E. coli, Campylobacter and many other bacteria and fungal growths.

X2 features

- Variable intensity: 0% to 100%.
- Smooth, fully enclosed head to prevent dust ingress.
- Excellent colour rendering - totally natural skin tones.
- Emits no infrared radiation - no increase in temperature in the light-field.
- A strong beam of light with an even intensity across the entire area for clearer viewing and reduced eye strain.
- No life-risk voltage at the light-head.
- BioProtect® anti-microbial coating for infection control - reduces the population of bacteria such as MRSA and E.Coli by between 99.99% and 99.9999% within 24 hours.
- Optional 3-4 hour battery back-up available

Our most versatile examination light, available in a range of mount and arm options.

X200LR/X240LR
wall mount



X210LW
wall mount



X240LE1
wall mount



X240LE2
wall mount



X230LP
panel mount



X200LR/X240LR
rail mount



X200LFD/ M/
X240LFD/ M
fixed desk mount





X2
spring-balanced arm
desk mount



X2
gooseneck
panel mount



X2
gooseneck
IEC wall mount

Superb LED output



3-LED module
offering 32,000
lux @ 0.5m

Single-handed control



Power and light
intensity control
on rear of head



X2
gooseneck
mobile base



X200LD/X240LD
desk mount



X200LDS
weighted desk
stand



X200LM
mobile mount



X240LM
weighted mobile

X2 range options



Our 5-Year warranty enables peace of mind from a name you can trust

X2 specifications

Light source	LED
Light intensity @ 0.5m	32,000 lux ±5%
Light intensity @ 0.75m	14,000 lux ±5%
Light intensity @ 1.0m	8,000 lux ±5%
Light intensity adjustment range	10 - 100%
Colour temperature (Kelvin)	4,300K ±500
Colour rendering index (CRI)	95
Colour rendering (R9)	88
Light field diameter (D50)	@ 0.5m: 120mm
	@ 0.75m: 135mm
	@ 1.0m: 180mm
Light field diameter (D10)	@ 0.5m: 230mm
	@ 0.75m: 325mm
	@ 1.0m: 460mm
Number of LED's	3
Power consumption	12W 0.1A
Average working life	>50,000 hours
Input supply rating	100 - 240V AC 50/60Hz
Output supply rating	12V DC 1A
Temperature rise on patient/user	≤2°C
Warranty period	5 years
NHS E-class code	FBU, FKR
Commodity code	9018 908400
GMDN code	12276

These specifications apply to all models within the X2 range.

X2 gooseneck



This version of the X2 features our classic flexible gooseneck that enables you to bring the light head to exactly where you need it. The X2 range can be supplied with a variety of mounting options, all of which are interchangeable.

All versions listed below are supplied with a plug-top power supply as standard.

X2 models available

X200LW	X2 wall mounted LED examination light
X200LR	X2 rail mounted LED examination light
X200LD	X2 desk clamp LED examination light
X200LFD	X2 fixed desk mount LED examination light
X200LDS	X2 desk stand LED examination light
X200LM	X2 mobile LED examination light
XRAIL	1m Medical Rail for mounting X200LR (includes wall fixings)
XBB24LEDCW	24V battery backup power system*

*special order

X2 gooseneck hard-wired options

The X2 hard-wired version carries our flexible gooseneck and has an integrated power supply housed within the base of the neck.

The X2 can be supplied with an IEC cable for a standard plug socket* or for hard-wiring directly into the wall via the rear of the mounting box.

*international plug types available

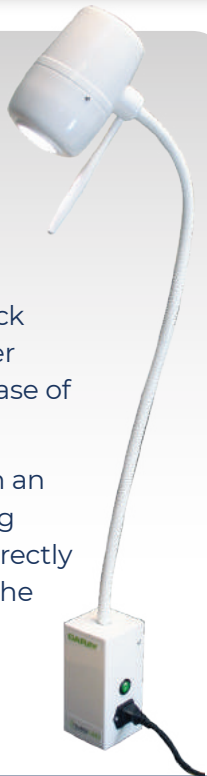

X2 spring arm

With the head mounted onto a spring-balanced arm designed to hold the light in position, this model is the most versatile product within the X2 range.

An extensive choice of mounting options extends its flexibility, including plug-top and hard-wired variants.



X2 models available

X210LW	X2 wall mounted LED examination light with IEC cable
X210LE	X2 wall mounted LED examination light electrician fit (flush fit)
X210LR	X2 rail mounted LED examination light
XRAIL	1m Medical Rail for mounting X210LR
X230LP	X2 bed-head panel mounted LED examination light with flush fit installation kit

X2 models available

X240LW	X2 wall mounted LED examination light
X240LR	X2 rail mounted LED examination light
X240LD	X2 desk clamp LED examination light
X240LFD	X2 fixed desk mount LED examination light
X240LM	X2 mobile LED examination light
X240LE1	X2 hardwired BESA wall mount LED examination light
X240LE2	X2 LED hardwired wall mount examination light with separate transformer*
X240LE3	X2 LED hardwired panel mount examination light with separate transformer*
X240LE4	X2 LED hardwired wall mount examination light - with integral transformer*
XRAIL	1m Medical Rail for mounting X240LR (includes wall fixings)
XBB24LEDCW	24V battery backup power system*

*special order

Bespoke solutions available, please call.



X2
gooseneck
panel mount

Exclusively designed for mounting onto a bed-head panel.

X3

The **DARAY**® X3 LED examination light is designed specifically for use during medical consultation and diagnosis.

The X3 is available with a wide range of mount options to ensure your examination light is exactly where you need it. It has a smooth, spring balanced arm and a telescopic ceiling tube making the light extremely versatile, perfect for gynaecological procedures.

Utilising LED technology, this general examination light has been developed to provide an intense beam with excellent colour rendering properties.

The X3 has a low total cost of ownership, costing up to 75% less to run than equivalent halogen lights. This light has around 50,000 hours of life from the LED light engine equating to around 25 years of clinical use. The X3 requires minimal maintenance and has a smooth, fully enclosed BioProtect® head to assist with the management of infection control. This is an ideal light for GP surgeries and clinics where flexibility and performance are crucial.



X3
hard-wired wall mount
integral transformer

X3 features

- A strong beam of light with an even intensity across the entire area for clearer viewing and reduced eye-strain
- One touch variable intensity
- Telescopic ceiling tube – extremely versatile
- Balanced arm with excellent range of movement
- 1000mm reach - ideal for general examinations

X3 environmental features

- Costs up to 75% less to run than halogen
- 50,000 hours of life from the LED light engine
- No more bulbs to change - reduces waste by 95% over the light's lifetime
- All metal chassis and light-head - hardwearing and can be fully recycled
- No halogen, mercury, cadmium, lead or CFCs. No chemicals harmful to the environment
- DARAY's LED technology has an intense clear white light beam equivalent to 75W halogen whilst consuming just 14W

(Figures based on 5.5 hours use per day)

X3 specifications

Light intensity @ 0.5m	64,000 lux ±5%
Light intensity @ 1m	17,000 lux ±5%
Colour temperature	4,300K ±500
Colour rendering index (CRI)	95
Colour rendering (R9)	88
Number of LED's	6
Light field diameter (D10)	@ 0.75m: 255mm
Power consumption	14W 0.2A
Average working life	>50,000 hours
Warranty period	5 years

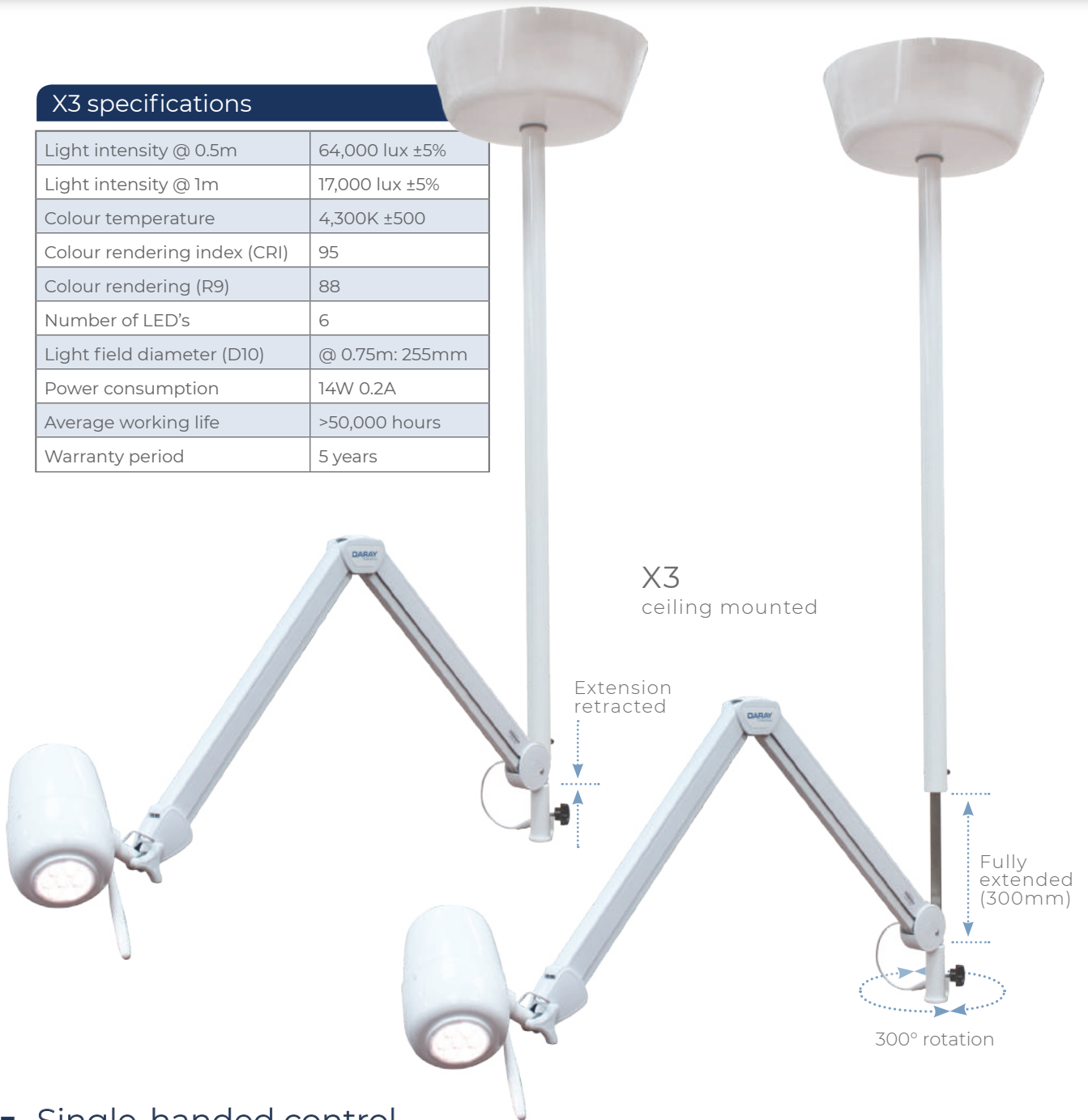

X3 ceiling mounted

- Single-handed control
- on/off and variable intensity



Telescopic ceiling tube



6 LED module



Spring balanced arm



X3 products available

X340LC	X3 ceiling mounted LED examination light
X340LW	X3 wall mounted LED examination light
X340LR	X3 rail mounted LED examination light
X340LD	X3 desk clamp LED examination light
X340LFDM	X3 fixed desk mount LED examination light
X340LM	X3 mobile LED examination light
X340LE1	X3 hardwired BESA wall mount LED examination light*
X340LE2	X3 hardwired wall mount LED examination light with separate transformer*
X340LE3	X3 hardwired panel mount LED examination light with separate transformer*
X340LE4	X3 hardwired wall mount LED examination light with integral transformer*
XRAIL	1m medical rail for mounting X340LR (includes wall fixings)
XBB24LEDCW	24V battery backup power system*

*Special order. Bespoke solutions available, please call

Mounting height

Recommended mounting height for the above ceiling mount version is 1900mm from floor level to the bottom of outer vertical tube.

Cut tube to desired length. 1m tube supplied as standard. A 2m tube is available for higher ceilings.

Choose your mounting option

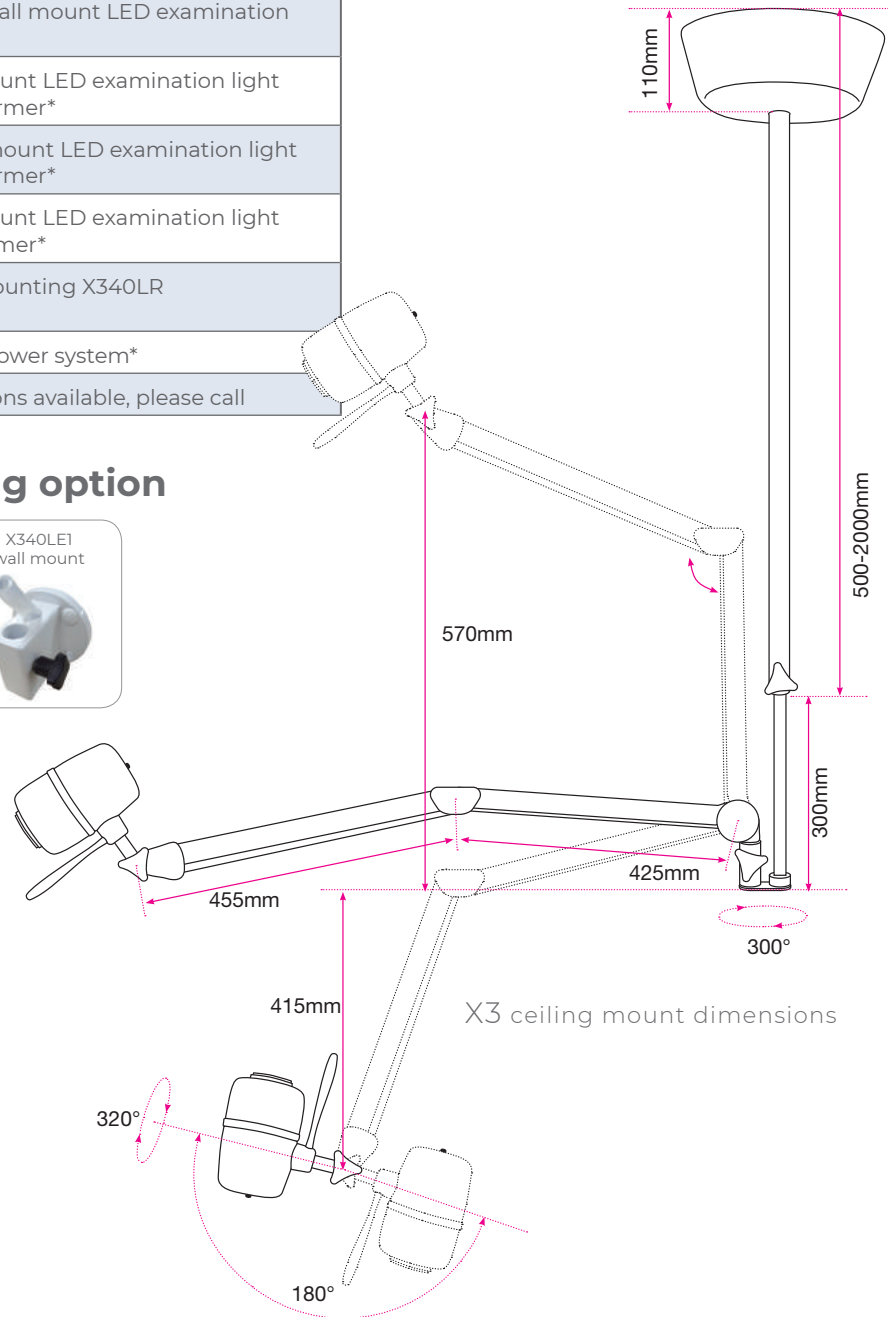

ABOUT DARAY

DARAY have been established in the medical, dental and veterinary markets since 1968, building exceptional and durable products. We shall continue to innovate; aiming to excel in our endeavours to deliver reliable solutions.

X4 flexible mobile LED exam light

The **DARAY**® X4 flexible mobile option is a high-quality, extremely efficient examination light offering the versatility of a stable mobile base with a flexible head mounting.

The X4 flexible mobile LED examination light can be positioned quickly and accurately, whilst remaining stable throughout. Originally designed specifically for gynaecological procedure, it is suitable for all exam uses.

The light-head gives a high-intensity output (120,000 lux @ 0.5m) and has no heat in the beam ensuring patient comfortability. With around 50,000 hours lamp life, the X4 is a cost effective, energy efficient lighting solution.

The X4 is the most versatile mobile LED medical examination light available. Its range of movement was initially designed for general examination use, this has been extended to the specific needs of the Gynaecological department.

It is easily controlled via a single switch, turning on and off and changing the light's intensity without the need for two hands.

All mobile castors are anti-static for extra reassurance.



Environmentally-friendly products from **DARAY**® **Our green promise**

- DARAY's LED technology has an intense clear white light beam equivalent to 75W halogen, whilst consuming only 17W.
- 50,000 hours of life from the LED light engine – that's over 25 years of normal clinical use.*
- No more bulbs to change - reduces waste by 95% over the light's lifetime.
- No halogen, mercury, cadmium, lead or CFCs. No chemicals harmful to the environment.
- All-metal chassis and light-head, not only hard-wearing, but can be fully recycled when the light comes to the end of its life.

*Based on 5.5 hours use per day



Versatile range of movement

Infinitely positionable

X4 flex mobile features

- Designed specifically for gynaecological examinations
- Fully enclosed head
- One touch control
- Variable intensity from 10 to 100%
- Excellent colour rendering - totally natural skin tones
- Emits no infrared radiation - no increase in temperature in the light-field
- Strong beam of light with an even intensity across the entire area for clearer viewing and reduced eye strain
- No life-risk voltage at the light head
- BioProtect® anti-microbial coating for infection control



Battery backup option



Switch on light head adjusts light intensity.



BioProtect®
the invisible shield against bacteria

BioProtect® is an antimicrobial solution coating applied to DARAY's products for infection control.

Infection is the highest risk in patient environments. BioProtect® provides excellent protection against bacteria such as MRSA, Salmonella, E. coli, Campylobacter and many other bacteria and fungal growths.

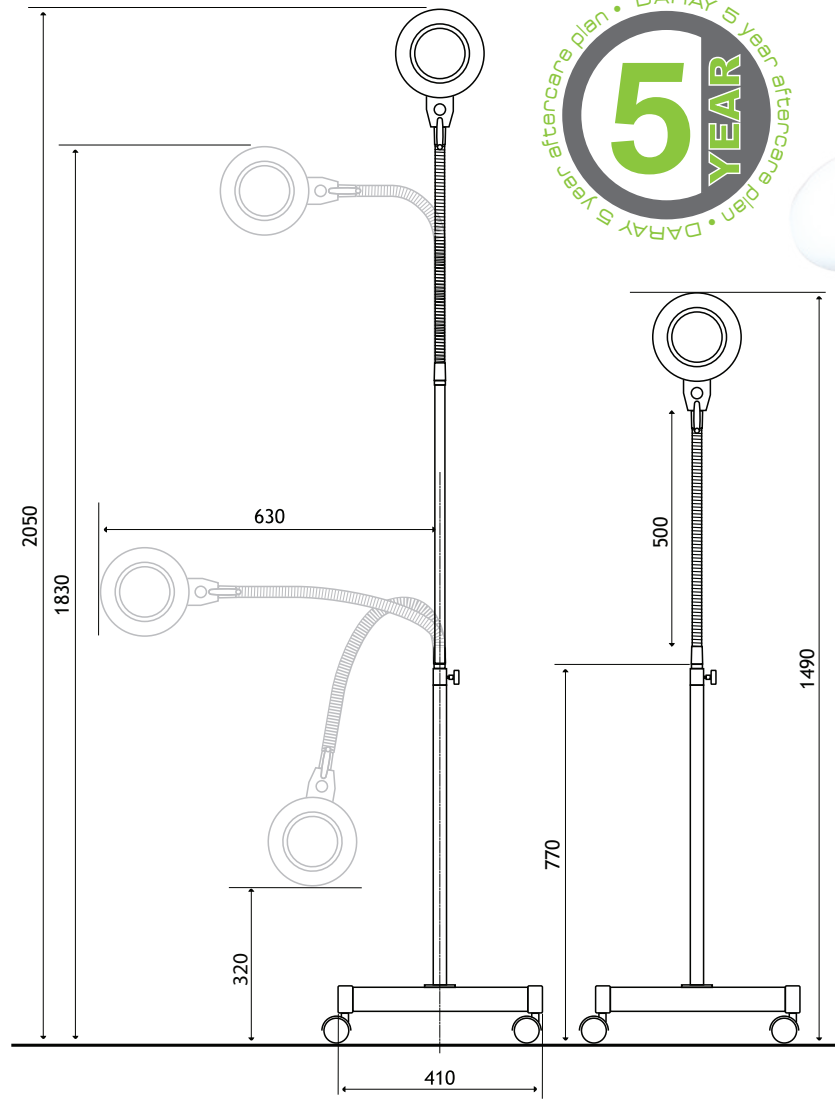

All measurements in millimetres



X4 flex mobile specifications

Average working life	>50,000 Hours
Number of LED's	7
Light intensity @ 0.5m	120,000 lux ±5%
Light intensity @ 0.75m	64,000 lux ±5%
Colour temperature	4,300K ±500
Colour rendering (CRI)	95
Color rendering (R9)	88
Light field diameter (D10)	@ 0.75m: 200mm
Mass	12kg
Power consumption	16W 0.19A
Input voltage	100 - 240V AC 50/60 Hz
Cable length	5m (high visibility)

Mounting and base
 Stable mobile 'H' base made of steel with BioProtect® antimicrobial coating and four anti-static castors; 2 locking.

X4 flex mobile products available

X400LFM	X4 flexible mobile LED examination light
X400LFMSP1	X4 flexible mobile LED examination light with 24V battery back-up (special order)
D15412	Voltage protector

X4

The X4 examination light features a large diameter light patch providing excellent illumination.

This model boasts single-handed lighting control, on/off and variable intensity, from a single switch located next to the light head. A smooth, fully-enclosed light head and arm system assists with the management of infection control.

Available as wall or ceiling mounted option or as a mobile freestanding unit, which include the most versatile spring-balanced suspension arms available for effortless repositioning.

X4 features

- LED technology provides energy and cost saving over the lifetime of the product.
- Variable Intensity from 0% to 100%.
- BioProtect® antimicrobial coating on all painted surfaces to assist with infection control management.
- Excellent colour rendering - totally natural skin tones.
- Emits no infrared radiation - no increase in temperature in the light-field.
- A strong beam of light with an even intensity across the entire area for clearer viewing and reduced eye strain.
- 5-Year Warranty
- No life-risk voltage at the light-head.

The **DARAY**® X4 premium quality LED examination light is suitable for use in all general medical diagnoses and procedures, and available in a range of mounting choices.



X4
Mobile mount



BioProtect®
the invisible shield against bacteria

BioProtect® is an antimicrobial solution coating applied to DARAY's products for infection control.

Infection is the highest risk in patient environments. BioProtect® provides excellent protection against bacteria such as MRSA, Salmonella, E. coli, Campylobacter and many other bacteria and fungal growths.

Spring-balanced fingertip movement



Ceiling mount cover (sold separately)

X4 Wall mounted

X4 Ceiling mounted

Single-handed control:
On/off and variable intensity

Massive range of movement



Spring-balanced arm offers versatile movement and easy positioning

This model features a strong beam of light with an even intensity across the entire area for clearer viewing and reduced eye-strain.

The longer reach of the dual-arm pivot system makes this light suitable for a range of clinical applications, including gynaecology.

X4 specifications

Light source	LED
Light intensity (lux) @ 0.5m	120,000 lux ±5%
Light intensity (lux) @ 1.0m	40,000 lux ±5%
Light intensity adjustment range	5% - 100%
Colour temperature (Kelvin)	4,300K ±500
Light field diameter (D50)	@ 1.0m: 125mm
Light field diameter (D10)	@ 1.0m: 220mm
Power consumption	16W 0.19A
Average working life	>50,000 hours



The switch alongside the light head, controls the power and adjustable light intensity.

Product dimensions: X4 ceiling mount

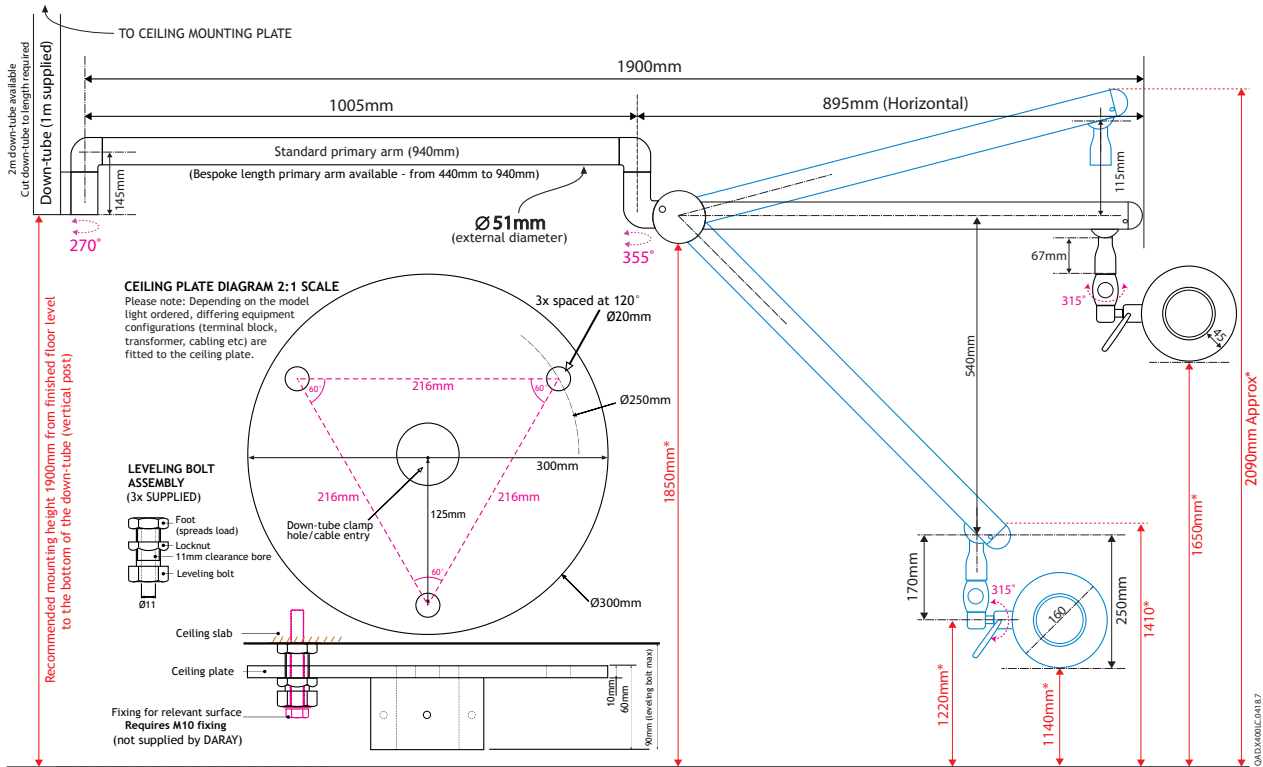

*All dimensions shown in red are based on a suggested mounting height (see measurement to UNDERSIDE of down-tube on far left). For specific applications and environments, the mounting bracket should be installed at a height so that, when fitted, the lighthead is as near to the required position as possible. Actual location should be dependent on intended use and desired reach. Common sense should always prevail.

Product dimensions: X4 wall mount

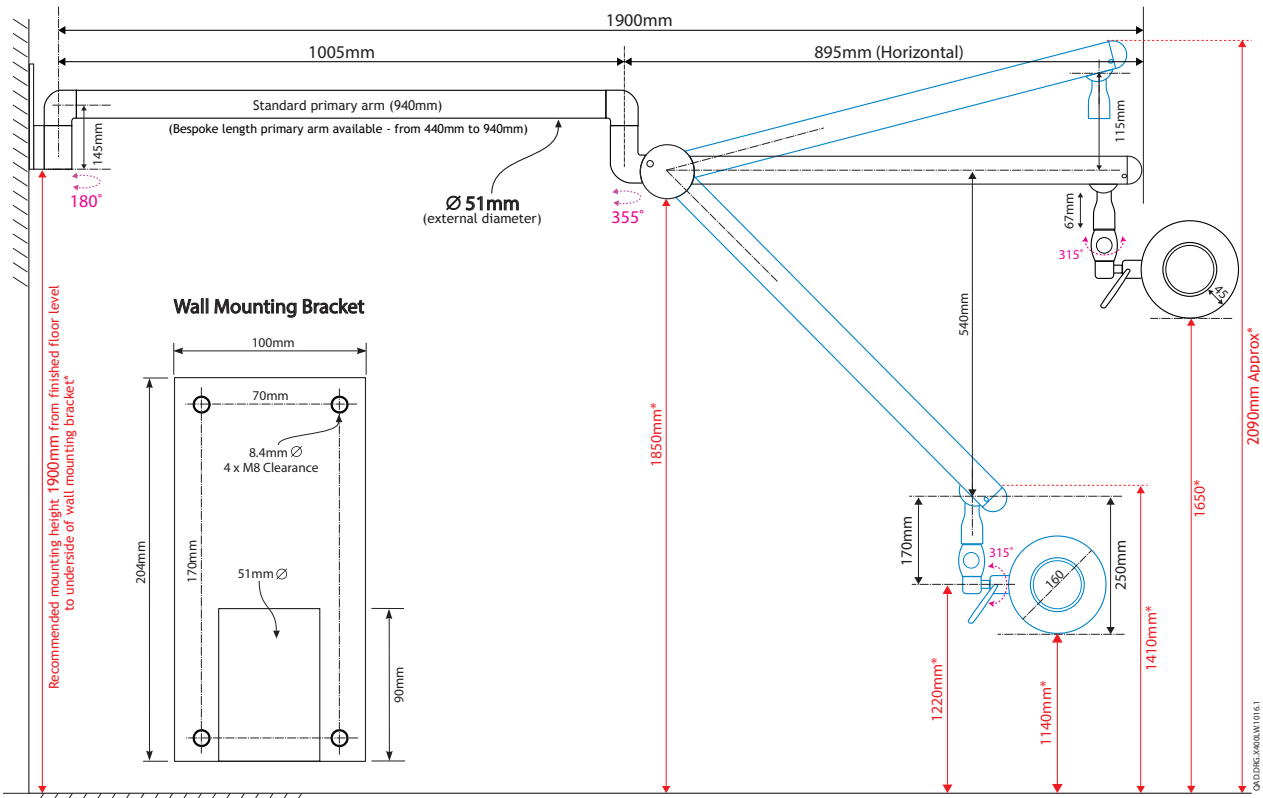

*All dimensions shown in red are based on a suggested mounting height (see measurement to wall bracket on far left). For specific applications and environments, the mounting bracket should be installed at a height so that, when fitted, the lighthead is as near to the required position as possible. Actual location should be dependent on intended use and desired reach. Common sense should always prevail.

Product dimensions:
X4 mobile mount

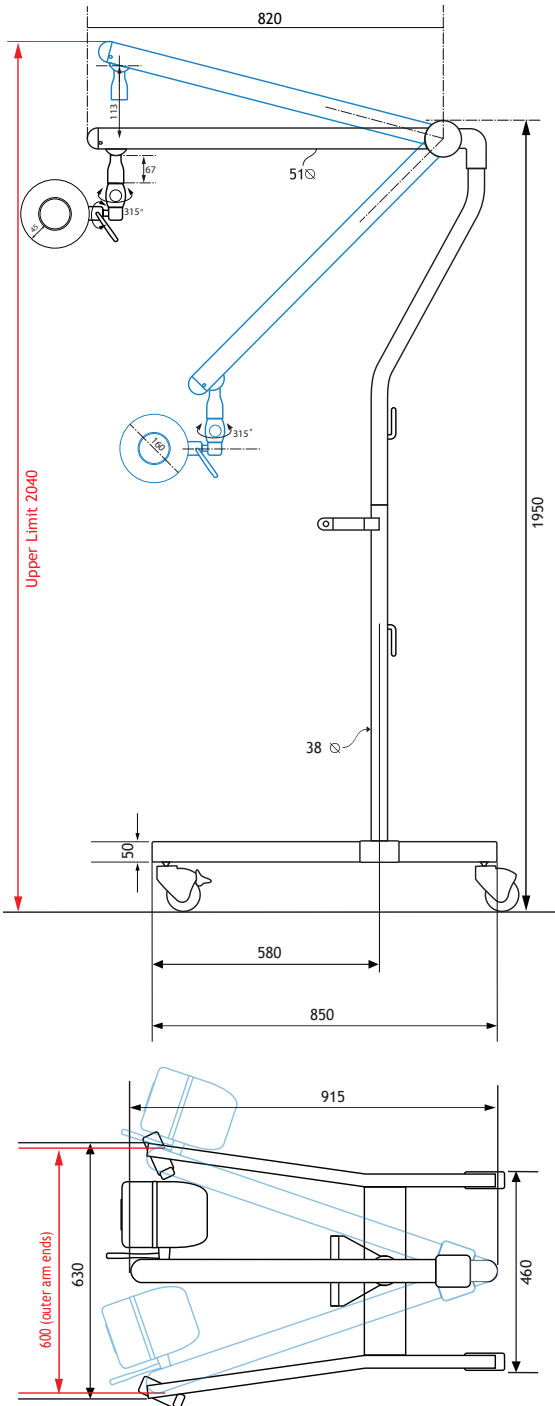

X4
Ceiling mounted

X4 products available

X400LC	X4 ceiling mount LED examination light
X400LW	X4 wall mounted LED examination light
X400LM	X4 mobile LED examination light
CMC	Ceiling mount cover (required for conventional ceilings)
XBB24LEDCW	24V battery back-up power system



Variable Colour Exam Lighting

DARAY® X7 examination lights are both powerful and incredibly flexible, featuring variable colour temperature adjustment.

The X7 is available with a wide range of mounting options to ensure your light is positioned exactly where it is needed. Available in two arm options; flexible gooseneck or spring-balanced arm, and a range of plug-top and hard-wired mounting options, the X7 is suited for all clinical needs.

Utilising LED technology, this low-maintenance examination light has been developed to provide an intense beam with excellent colour rendering properties.

The X7 has a low total cost of ownership, costing up to 75% less to run than equivalent halogen lights. It has around 50,000 hours of life from the LED light engine equating to around 25 years of clinical use.

This is an ideal light for GP surgeries and clinics where flexibility and performance are crucial.



X7 range features a removable autoclavable handle, to reduce the risk of cross infection.



Versatility in our smallest package

Product features

- A strong beam of light with an even intensity across the entire area for clearer viewing and reduced eye strain
- Variable intensity and colour temperature controlled directly from the light head.
- Telescopic ceiling tube (ceiling mount version only).
- Spring-balanced arm or flexible gooseneck with excellent range of movement.
- A wide selection of mounting options, including plug-top and hard-wired variants.

X7 environmental features

- Costs up to 75% less to run than halogen
- 50,000 hours of life from the LED light engine
- No more bulbs to change - reduces waste by 95% over the light's lifetime
- All metal chassis and light-head, hardwearing and can be fully recycled
- No halogen, mercury, cadmium, lead or CFCs. No chemicals harmful to the environment
- DARAY's LED technology has an intense clear white light beam equivalent to 75W halogen, whilst consuming just 16W

(Figures based on 5.5 hours use per day)

X7 specifications

Light source	LED
Light intensity (lux) @ 0.5m	50,000 lux
Light intensity (lux) @ 1m	22,500 lux
Colour temperature	3,600 - 5,000K (±500K)
Colour rendering index	Ra - 95, R9 - 88
Power consumption	16W / 0.14A
Base of arm rotation	180 - 300°
Average working life	50,000 hours
Input voltage	100 - 240V AC 50/60 Hz
Output voltage	12V DC / 1A
Head rotation	320°
Warranty	5 years



X7
spring-arm
wall mount

Single-handed control
on all X7 models



Spring-balanced
arm offering
versatile movement
and easy positioning



Multiple
LED's on
the light
head pool to
form a clear
and uniform
light patch

Digital control panel

The X7 features a unique digital control panel on the head to control light intensity and colour temperature.

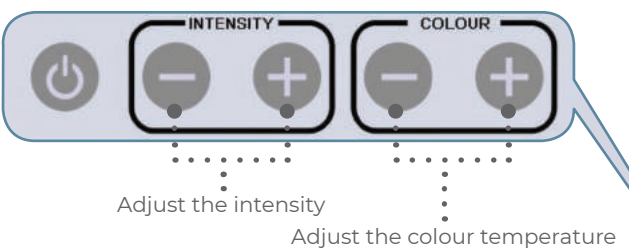

Adjust the intensity
Adjust the colour temperature

Choose your mounting option

<p>X700LR/X740LR wall mount</p>	<p>X700LR/X740LR rail mount</p>	<p>X700LD/X740LD desk mount</p>	
<p>X700LM mobile mount</p>	<p>X740LM mobile mount</p>	<p>X700LFD/ X740LFD fixed desk mount</p>	
<p>X740LE1 wall mount</p>	<p>X740LE2 wall mount</p>	<p>X730LP panel mount</p>	
<p>X740LE3 panel mount</p>	<p>X740LE4 panel mount</p>	<p>X710LW wall mount</p>	
			<p>X740LC ceiling mount</p>

Removable, autoclavable
positioning handle



X7
gooseneck
wall mount

Spectacular
colour rendering



Remarkable
articulation throughout



X7 products available

Flexible gooseneck, plug-top PSU

X700LW	X7 wall mounted LED examination light
X700LR	X7 rail mounted LED examination light
X700LD	X7 desk clamp LED examination light
X700LFDM	X7 fixed desk mount LED examination light
X700LM	X7 mobile LED examination light
XRAIL	1m medical rail for mounting X700LR (includes wall fixings)
XBB24LEDCW	24V battery backup power system*

Flexible gooseneck, integrated PSU

X710LW	X7 wall mounted LED examination light - with IEC cable
X710LE	X7 wall mounted LED examination light - electricians fit (flush fit)
X710LR	X7 rail mounted LED examination light
XRAIL	1m Medical Rail for mounting X710LR (includes wall fixings)

Flexible gooseneck, for bedhead mounting

X730LP	X7 bedhead panel mounted LED examination light with flush fitting installation kit
--------	--

Spring-balanced arm, plug-top PSU and hardwired options

X740LC	X7 ceiling mounted LED examination light
X740LW	X7 wall mounted LED examination light
X740LR	X7 rail mounted LED examination light
X740LD	X7 desk clamp LED examination light
X740LFDM	X7 fixed desk mount LED examination light
X740LM	X7 mobile LED examination light
X740LE1	X7 hardwired BESA wall mount LED examination light*
X740LE2	X7 hardwired wall mount LED examination light with separate transformer*
X740LE3	X7 hardwired panel mount LED examination light with separate transformer*
X740LE4	X7 hardwired wall mount LED examination light with integral transformer*
XRAIL	1m Medical Rail for mounting X740LR (includes wall fixings)
XBB24LEDCW	24V battery backup power system*

*special order

Colour temperature explained

Warm white 3000°K Bright white 5000°K Cool white

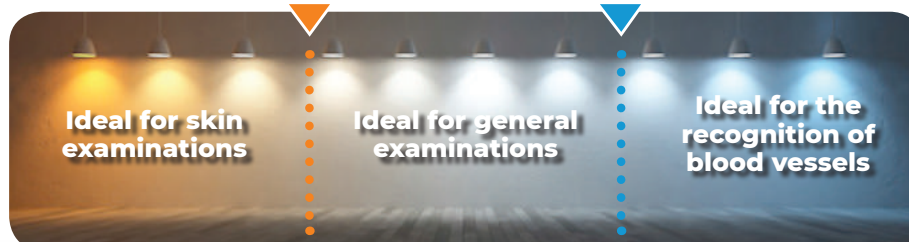

Nature's choice

LED technology

from

DARAY[®]
Medical



Why choose LED?

- Costs up to 75% less to run than equivalent halogen lighting.
- No increase in temperature in the light-field.
- Totally natural skin tones.
- Variable intensity.
- A strong, even beam for clearer viewing and reduced eye-strain.
- Long lamp-life.
- Fully recyclable.
- No chemicals harmful to the environment.

View our entire product range at:

www.daray.co.uk

QUICK REFERENCE GUIDE

X1 range

Order Codes

X100LW	X1 wall mounted LED examination light
X100LR	X1 rail mounted LED examination light
X100LD	X1 desk clamp LED examination light
X100LDS	X1 weighted desk stand LED examination light
X100LFDM	X1 fixed desk mount LED examination light
X100LM	X1 mobile LED examination light
XRAIL	Medical rail 1m length with fixings

X2 range

Order Codes

X200LW	X2 wall mounted LED examination light
X200LR	X2 rail mounted LED examination light
X200LD	X2 desk clamp LED examination light
X200LFDM	X2 fixed desk mount LED examination light
X200LM	X2 mobile LED examination light

X210LW	X2 wall mounted LED examination light - with IEC
X210LE	X2 wall mounted LED examination light - (flush fit)
X210LR	X2 rail mounted LED examination light

X230LP	X2 bedhead panel mounted LED examination light with flush fitting installation kit
--------	--

X240LW	X2 wall mounted LED examination light
X240LR	X2 rail mounted LED examination light
X240LD	X2 desk clamp LED examination light
X240LFDM	X2 fixed desk mount LED examination light
X240LM	X2 mobile LED examination light
X240LE1	X2 hardwired BESA wall mount LED examination light
X240LE2	X2 hardwired wall mount LED examination light - with separate transformer
X240LE3	X2 hardwired panel mount LED examination light - with separate transformer
X240LE4	X2 hardwired wall mount LED examination light - with integral transformer
XRAIL	1m Medical Rail for mounting X200LR/X210LR/X240LR
XBB24LEDCW	24V battery backup power system (special order)

X4 flexible mobile

Order Codes

X400LFM	X4 flexible mobile LED examination light
X400LFMSP1	X4 flexible mobile LED examination light with 24V battery back-up (special order)
D15412	Voltage protector



All products comply with BS EN 60601-2-41

www.daray.com

Tel: 0800 804 8384 Email: sales@daray.co.uk

Edison House, Robian Way, Derbyshire DE11 9DH

X3 range

Order Codes

X340LC	X3 ceiling mounted LED examination light
X340LW	X3 wall mounted LED examination light
X340LR	X3 rail mounted LED examination light
X340LD	X3 desk clamp LED examination light
X340LFDM	X3 fixed desk mount LED examination light
X340LM	X3 mobile examination LED light
X340LE1	X3 hardwired BESA wall mount LED examination light
X340LE2	X3 hardwired wall mount LED examination light with separate transformer
X340LE3	X3 hardwired panel mount LED examination light with separate transformer
X340LE4	X3 hardwired wall mount LED examination light with integral transformer
XRAIL	1m Medical Rail for mounting X340LR
XBB24LEDCW	24V battery backup power system (Special order)

X4 range

Order Codes

X400LC	X4 ceiling mounted LED examination light
X400LW	X4 wall mounted LED examination light
X400LM	X4 mobile LED examination light
CMC	Ceiling mount cover (for conventional ceilings)
XBB24LEDCW	24V battery back-up power system

X7 range

Order Codes

X700LW	X7 wall mounted LED examination light
X700LR	X7 rail mounted LED examination light
X700LD	X7 desk clamp LED examination light
X700LFDM	X7 fixed desk mount LED examination light
X700LM	X7 mobile LED examination light

X710LW	X7 wall mounted LED examination light - with IEC
X710LE	X7 wall mounted LED examination light - (flush fit)
X710LR	X7 rail mounted LED examination light

X730LP	X7 bedhead panel mounted LED examination light - with flush fitting installation kit
--------	--

X740LC	X7 ceiling mounted LED examination light
X740LW	X7 wall mounted LED examination light
X740LR	X7 rail mounted LED examination light
X740LD	X7 desk clamp LED examination light
X740LFDM	X7 fixed desk mount LED examination light
X740LM	X7 mobile LED examination light
X740LE1	X7 hardwired BESA wall mount LED examination light
X740LE2	X7 hardwired wall mount LED examination light - with separate transformer (special order)
X740LE3	X7 hardwired panel mount LED examination light - with separate transformer (special order)
X740LE4	X7 hardwired wall mount LED examination light - with integral transformer (special order)

Daray make every effort to ensure that the information in this document is correct and accurate, however, we cannot be held responsible for errors and omissions. Daray reserves the right to alter specifications and to add and withdraw products without notice.

QAB.XSERIESBROCHURE.1120.2



DARAY[®]
Medical

Committed to excellence